

Sheet: Alimentation

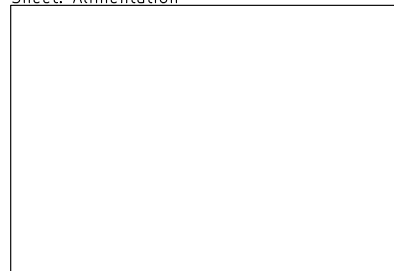

File: alim.sch

Sheet: pc

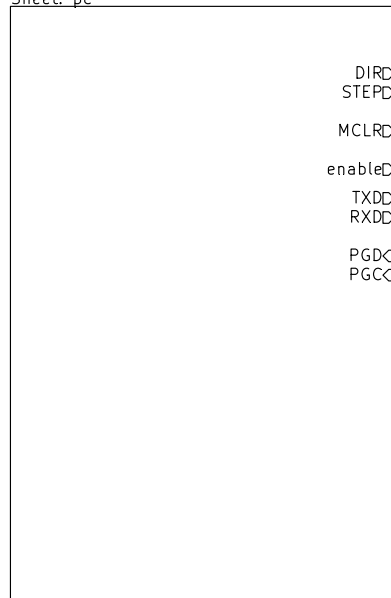

File: PC input.sch

Sheet: dspic

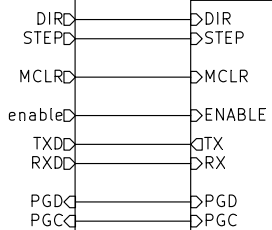

File: dsPIC.sch

Sheet: Interface controleur

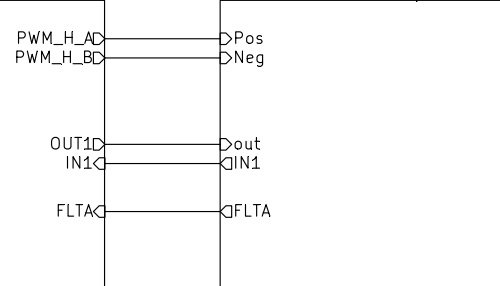

File: intf_ctrl.sch

Sheet: Encodeur

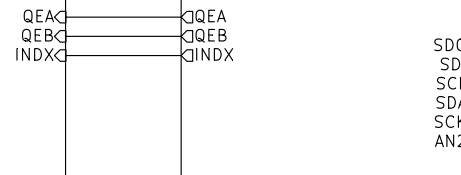

File: encoder.sch

SD0C
SD1C
SCLC
SDAC
SCKC
AN2C

File: yapsc.sch

Sheet: /

Title:

Size: A4

Date: 8 feb 2009

Rev:

KiCad E.D.A. eeschema (20100314 SVN-R2460)-final

Id: 1/6

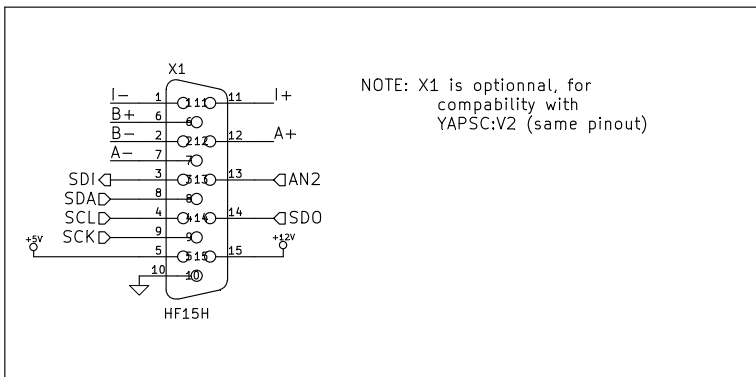
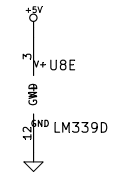
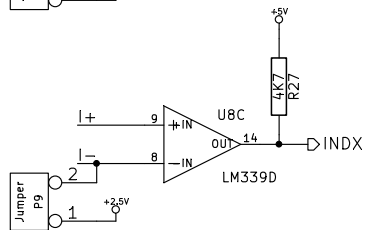
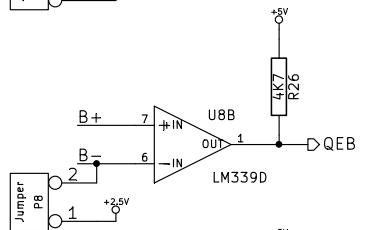
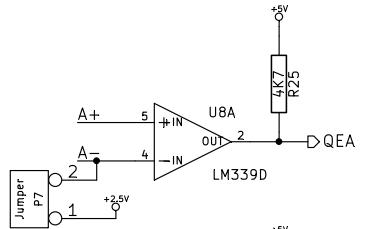
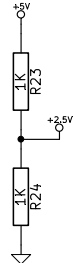
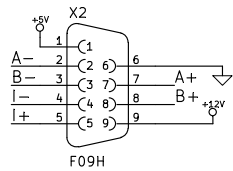

File: encoder.sch		Sheet: /Encodeur/	
Title:			
Size: A4	Date: 8 feb 2009		Rev:
KiCad E.D.A. eeschema (20100314 SVN-R2460)-final		Id: 2/6	

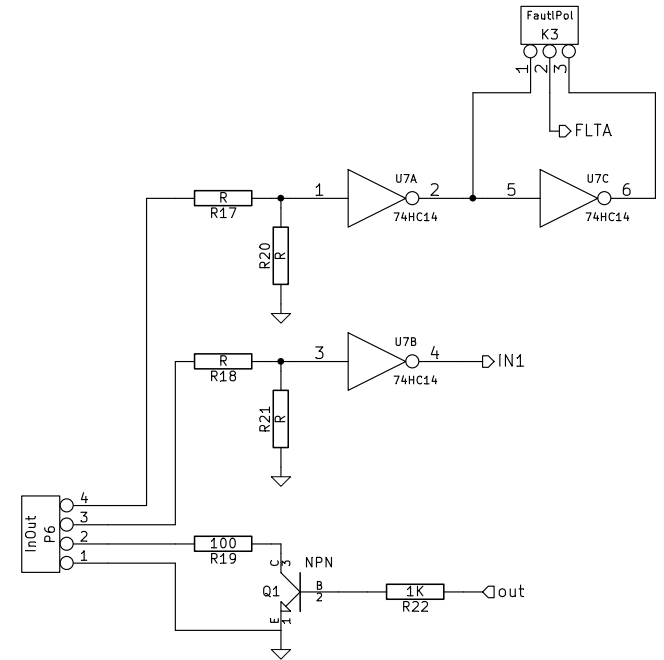
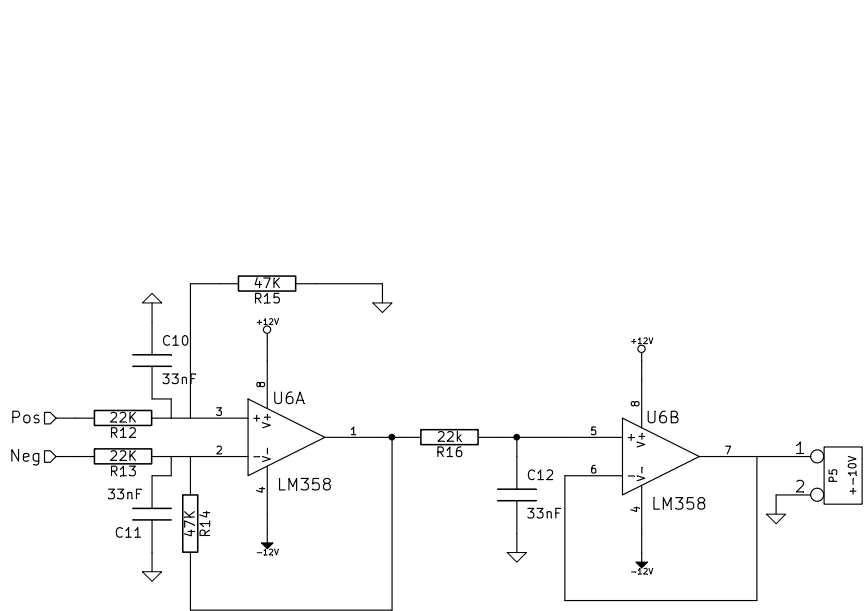

File: intf_ctrl.sch	
Sheet: /Interface controleur/	
Title:	
Size: A4	Date: 8 feb 2009
KiCad E.D.A. eeschema (20100314 SVN-R2460)-final	Rev: Id: 3/6

1 2 3 4 5

A

A

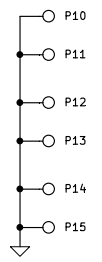

Fixation PCB

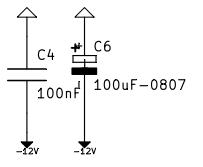
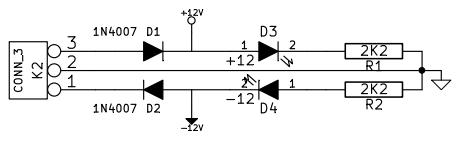
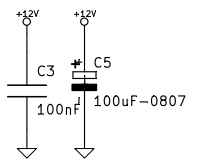
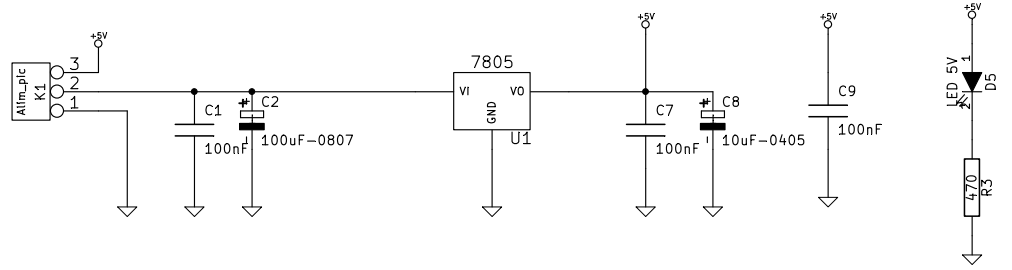

File: alim.sch		
Sheet: /Alimentation/		
Title:		
Size: A4	Date: 8 feb 2009	Rev:
KiCad E.D.A. eeschema (20100314 SVN-R2460)-final		Id: 4/6

1 2 3 4 5

C

C

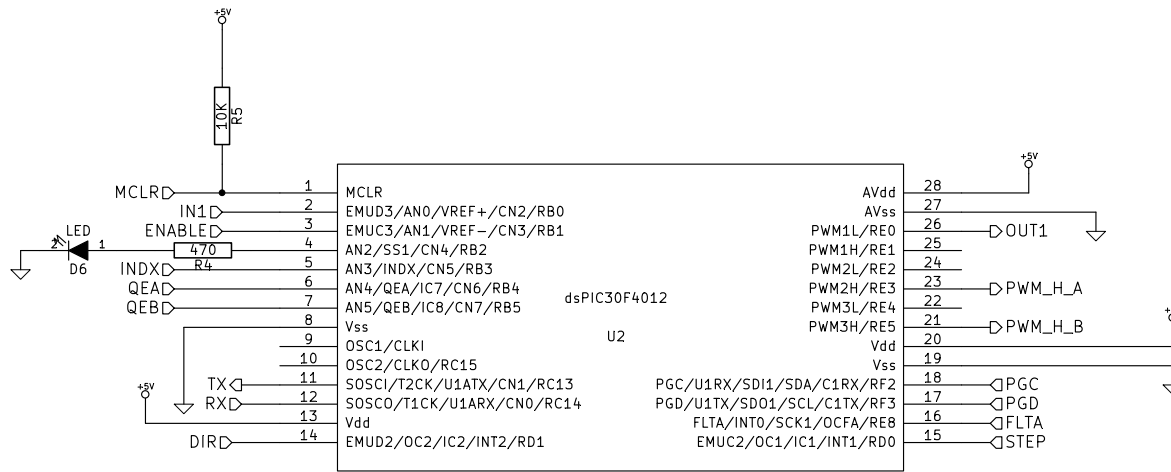

File: dsPIC.sch	
Sheet: /dspic/	
Title:	
Size: A4	Date: 8 feb 2009
KiCad E.D.A. eeschema (20100314 SVN-R2460)-final	Rev: Id: 5/6

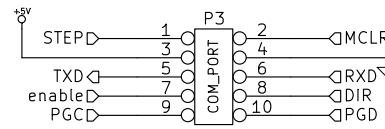
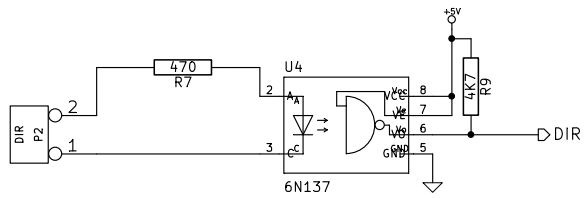
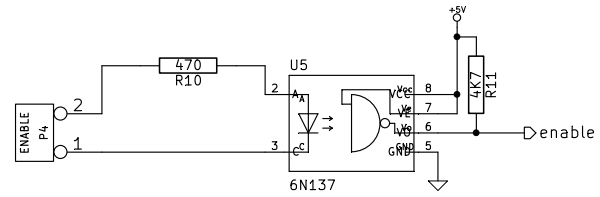
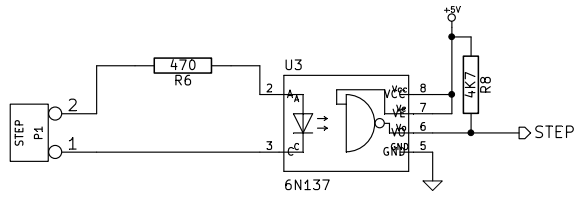

File: PC input.sch		
Sheet: /pc/		
Title:		
Size: A4	Date: 8 feb 2009	Rev:
KiCad E.D.A. eeschema (20100314 SVN-R2460)-final		Id: 6/6